

# NANOpure<sup>®</sup> Diamond<sup>™</sup> Life Science (UV/UF)

*ultrapure water system*

Operation Manual  
*Series 1193*

**Model No.**  
D11931

**Voltage**  
100V - 240V

---

# Table of Contents

Safety Information .....	3
Alert Signals.....	3
Warnings .....	3
Introduction .....	5
General Usage.....	5
General Specifications .....	6
Environmental Conditions .....	7
Declaration of Conformity .....	7
Unpacking .....	8
Installation .....	9
Choosing a Site .....	9
Ultrafilter Installation .....	10
UV Lamp Installation .....	11
Other Accessories .....	11
Bench Mounting .....	12
Wall Mounting .....	12
Installing the Control Panel in a Remote Location .....	13
Water Connections .....	14
Controls .....	15
Main Power Switch .....	15
Control Panel .....	15
Switches.....	16
Initial Operation .....	17
Cartridge Pack Installation.....	17
Initial Rinse .....	18
System Sanitization Procedure .....	19
Normal Operation.....	21
Dispensing Water.....	21
Automatic Dispensing .....	21
User Settings .....	22
Adjusting Display Brightness .....	22
Setting the Displayed Language .....	22
Setting the Date and Time .....	22
Setting the Cell Constant.....	23
Use of Standby Mode .....	25
Selecting the Set Point .....	25
Resetting the Sanitization Timer .....	26
Resetting the UV Timer .....	26
Setting Volumetric Dispensing .....	27
Setting Timed Dispensing .....	28
Performing a System Flush .....	28
Changing Purity Units .....	28
Temperature Compensation.....	29
Installing Float or Pressure Switch .....	30
N.I.S.T. Calibration Module .....	31
Performing an Electronic Calibration Using the Optional N.I.S.T. Calibration Module .....	31
Remote Dispenser .....	32
Computer/Printer Setup .....	33
Connecting NANOpure Dlamond to Computer and Communicating Through the RS-232 Port Using Hyperterminal or Procomm .....	33
Connecting and Starting the Printer .....	35
Printer Setup .....	36
Maintenance and Servicing .....	38
General Cleaning Instructions .....	38
Cell Cleaning .....	38
System Sanitization .....	38
System Depressurization .....	40
Cartridge Pack Replacement.....	40
0.2 Micron Filter Replacement.....	41
Ultrafilter Replacement .....	42
UV Lamp Replacement .....	42
Fuse Replacement.....	44
Shutdown .....	45
Troubleshooting .....	46
Replacement Parts .....	47
Flow Chart Operational Overview).....	52
Wiring Diagram .....	53
Ordering Procedures .....	54
One Year Limited Warranty .....	55

# Safety Information

---

## Alert Signals



### Warning

Warnings alert you to a possibility of personal injury.



### Caution

Cautions alert you to a possibility of damage to the equipment.



### Note

Notes alert you to pertinent facts and conditions.



### Note

The UV lamp contains mercury. If broken or no longer needed, do not dispose of the UV lamp in the trash. Recycle or dispose of the UV lamp as hazardous waste.

Your Barnstead|Thermolyne NANOpure Diamond Life Science (UV/UF) ultrapure water system has been designed with function, reliability, and safety in mind. It is your responsibility to install it in conformance with local electrical codes. This manual contains important safety information. You must carefully read and understand the contents of this manual prior to the use of this equipment. For safe operation, please pay attention to the alert signals throughout the manual.

Water purification technology employs one or more of the following: chemicals, electrical devices, mercury vapor lamps, steam and heated vessels. Care should be taken when installing, operating or servicing Barnstead products. The specific safety notes pertinent to this Barnstead product are listed below.

---

## Warnings

### To avoid electrical shock, always:

1. Use a properly grounded electrical outlet of correct voltage and current handling capacity.
2. Do not locate the NANOpure Diamond Life Science (UV/UF) directly over equipment that requires electrical service. Routine maintenance of this unit may involve water spillage and subsequent electrical shock hazard if improperly located.
3. Replace fuses with those of the same type and rating.
4. Disconnect from the power supply prior to maintenance and servicing.

### To avoid personal injury:

1. Do not use in the presence of flammable or combustible materials; fire or explosion may result. This device contains components which may ignite such materials.
2. This device is to be used with water feeds only. Sanitizing/cleaning agents must be used in compliance with instructions in this manual. Failure to comply with the above could result in explosion and personal injury.

---

## SAFETY INFORMATION

3. Avoid splashing disinfecting solutions on clothing or skin.
4. Ensure all piping connections are tight to avoid chemical leakage.
5. Ensure adequate ventilation.
6. Carefully follow manufacturer's safety instructions on labels of chemical containers and material safety data sheets.
7. Depressurize system prior to removing the cartridge pack.
8. This unit is equipped with an ultraviolet lamp. Ultraviolet radiation is harmful to the eyes and skin. Do not attempt to observe the lamp directly.
9. Refer servicing to qualified personnel.
10. A full cartridge pack may weigh about 20 lbs.

---

# Introduction

Congratulations on your purchase of a Barnstead|Thermolyne NANOpure Diamond Life Science (UV/UF) ultrapure water system. This water purification system is designed to provide nuclease-free (RNase and DNase), DNA-free, pyrogen-free, low TOC, high resistivity, reagent grade water that exceeds ASTM Type I, CAP and NCCLS Type I standards. It uses a four-stage deionization process combined with a UV lamp, an ultrafilter and a 0.2 micron filter to polish suitable feed water (distilled, deionized, or reverse osmosis) to produce pyrogen-free (<0.005 Eu/ml), low TOC (<5.0 ppb) water with a resistivity of up to 18.2 megohm-cm. Water resistivity is continuously monitored by a resistivity cell and displayed on a digital display.

The NANOpure Diamond Life Science (UV/UF) is designed to automatically clean the ultrafilter by flushing water through the filter for one minute every 12 hours. The water is sent to drain.

The electronics can be verified and calibrated utilizing a N.I.S.T. Traceable Calibration module. See accessory ordering information.

Please read the instructions carefully to ensure that you receive maximum benefit from the NANOpure Diamond Life Science (UV/UF). Also, please fill out and return the enclosed warranty registration card as it will help us assure you of proper warranty coverage.

---

## General Usage

Do not use this product for anything other than its intended usage.

---

# General Specifications

---

## Dimensions and Clearance Requirements

### Dimensions

13.4" W x 19.5" H x 16.9" D (34.0 x 49.5 x 42.8 cm)

---

### Clearances

Sides - 9" (22.9 cm) minimum for servicing.

Above - 3" (7.6 cm) minimum for removal of the top cover.

Front - 4.75" (12.1 cm) minimum for opening the front door.

---

## Feed Water Requirements

Types	RO, DI, distilled.
TOC	Less than 1.0 ppm.
Turbidity	1.0 N.T.U. maximum.
Pressure Range	Gravity feed to 100 psig (7kg/cm <sup>2</sup> ) maximum.
Temperature Range	4°C - 40°C (40-104°F)
TDS (CaCO <sub>3</sub> )	< 70 ppm
Silica	< 1 ppm
Silt	< 5% SDI

---

## Product Water

### Water Quality

Resistivity	> 18.0 mΩ-cm
TOC	Less than 5.0 ppb
Endotoxin	Less than 0.02 Eu/ml

---

### Flow Rate

1.5 lpm maximum at minimum inlet feed water pressure 10 PSIG with a new final filter.

---

### Volumetric Dispense

Accuracy: ± 5%

Repeatability: ± 3%

---

## Electrical Requirements

The NANOpure Diamond Life Science (UV/UF) is equipped with 2 power cords to be plugged into an electrical outlet of the appropriate voltage.

Voltage and Frequency (Nominal)

Model D11931            100-240 VAC, 47-63 Hz, 1 phase

---

## **Environmental Conditions**

Operating: 4°C - 49°C; 20% to 80% relative humidity, non-condensing. Installation Category II (over-voltage) in accordance with IEC 664. Pollution Degree 2 in accordance with IEC 664.  
Altitude limit: 3,500 meters.

Storage: -25°C to 65°C; 10% to 85% relative humidity.

---

## **Declaration of Conformity**

Barnstead|Thermolyne hereby declares under its sole responsibility that this product conforms with the technical requirements of the following standards:

EMC: EN 61000-3-2 Limits for Harmonic Current Emissions  
EN 61000-3-3 Limits for Voltage Fluctuations and Flicker  
EN 61326-1 Electrical Equipment for Measurement, Control, and Laboratory Use; Part I: General Requirements

Safety: EN 61010-1 Safety Requirements for Electrical Equipment for Measurement, Control and Laboratory Use; Part I: General Requirements

per the provisions of the Low Voltage Directive 73/23/EEC, as amended by 93/68/EEC.

The authorized representative located within the European Community is:

Electrothermal Engineering, Ltd.  
419 Sutton Road  
Southend On Sea  
Essex SS2 5PH  
United Kingdom

Copies of the Declaration of Conformity are available upon request.

---

# Unpacking

1. Remove the unit from its shipping container. Remove all contents carefully. **Ensure that the UV lamp, ultrafilter, feed and drain tubing, sanitization cartridge, wall bracket, accessory parts bag and power cords (see list below) are removed from the packaging materials before discarding.** Put the NANOpure Dlamond Life Science (UV/UF) on a bench.

UV Lamp	LMX13
Sanitization Cartridge	CMX25
Wall Bracket (Unit)	
Wall Bracket (Remote Display)	BC1190X10
Ultrafilter	FL1192X1

**Accessory Parts Bag Includes:**

Feed Water Tube, 3/8" O.D.	
Drain Tube, 14" O.D.	
240 V Power Cord w/Fuses	CRX70 (2, FZX54)
120 V Power Cord w/Fuses	CRX72 (2, FZX47)
Display Cable	WHX20
Blank Display	
Plug Adapter	CEX42

**Also required for installation:**

\* Customer Supplied Fasteners to mount unit and remote display.



# Installation



## Caution

Wall composition, condition and construction as well as fastener type must be considered when mounting this unit. The mounting surface and fasteners selected must be capable of supporting a minimum of 150 lbs.(68 kg). Inadequate support and/or fasteners may result in damage to mounting surface and/or equipment. If you are unsure of mounting surface composition, condition and construction or correct fasteners, consult your building maintenance group or contractor.



## Warning

Do not locate the NANOpure Dlamond Life Science (UV/UF) directly over equipment that requires electrical service. Routine maintenance of this unit may involve water spillage and subsequent electrical shock hazard if improperly located.

Do not use in the presence of flammable materials; fire or explosion may result. This device contains components which may ignite such materials.



## NOTE \*\*\*\*\*

***The outlet of a gravity feed storage reservoir must be above or at the same level as the inlet of the NANOpure Dlamond Life Science (UV/UF).***

\*\*\*\*\*

## Choosing a Site

The NANOpure Dlamond Life Science (UV/UF) features a removable control panel display which allows the system to be mounted almost anywhere within the laboratory. Use the wall bracket for wall mounted systems as a template to drill mounting holes. (The NANOpure Dlamond Life Science (UV/UF) does not include screws and fasteners for mounting.) Please refer to the “General Specifications” section for clearance requirements.

## INSTALLATION



### Note

Do not install the ultrafilter until the NANOpure Diamond Life Science (UV/UF) is ready for use. If the unit sits for longer than 72 hours without use, it will become contaminated and may affect product water quality.



### Note

The ultrafilter must be installed before the 0.2 micron filter. Please refer to "0.2 Micron Filter Replacement" under "Maintenance and Servicing" for instructions on how to replace the 0.2 micron filter.



Top side port with cap removed

Bottom side port with cap removed

*Ultrafilter with fittings*



Top connector

Velcro strap

Metal bracket

Bottom connector

*Ultrafilter Installation*

® Velcro is a registered Trademark of Velcro Industries B.V.

## Ultrafilter Installation

Remove the ultrafilter from its protective bag. Install the ultrafilter as follows:

1. Open the front (right side) door and right side door.
2. Remove restraints (twist tie) from the three tubes.
3. Locate the metal bracket and separate the Velcro® strap.
4. Remove the cap on the top side port of the ultrafilter (make sure the bottom cap on the bottom side port is secure). Insert side ports into the holes in the metal bracket.
5. Align the ultrafilter with the metal bracket ("This End Up" should be facing front) and push the bottom fitting tightly into the bottom connector.
6. Push the top fitting of the ultrafilter into the top connector, making sure the connection is tight.
7. Secure the ultrafilter with the velcro strap.
8. Connect tubing with luer fitting to the top side port.
9. Close and latch right side door and front (right side) door.

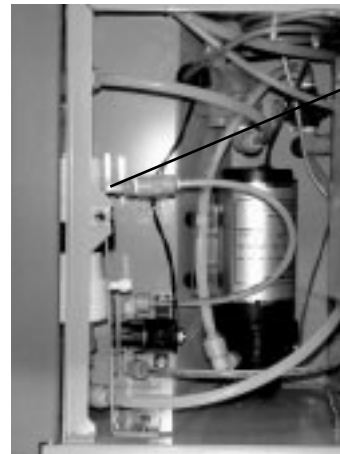

Top side port tubing with luer fitting

*Ultrafilter Connections (Right side view)*

**Note**

The UV lamp contains mercury. If broken or no longer needed, do not dispose of the UV lamp in the trash. Recycle or dispose of the UV lamp as hazardous waste.

**Caution**

**DO NOT TOUCH THE GLASS PORTION OF THE LAMP!** It is recommended that lint-free gloves be worn when handling the lamp. The glass portion must be free of fingerprints, perspiration, etc. Even a light coating of perspiration will reduce the effectiveness of the lamp. If the glass portion of the lamp is touched, clean it with a damp, lint-free cloth: use isopropyl alcohol as required.



*UV Lamp Installation - Left side view*

---

## UV Lamp Installation

Locate the UV chamber inside the left door of the NANOpure Diamond Life Science (UV/UF). Install the UV Lamp as follows:

1. Disconnect the power cord from the unit.
2. Access the left side of the unit by unlatching the screw securing the door with a flathead screwdriver. Open the door. The UV lamp will be installed vertically.
3. Remove the UV lamp from its packaging. **DO NOT TOUCH THE GLASS PORTION OF THE LAMP!** It is recommended that lint-free gloves be worn when handling the lamp. The glass portion must be free of fingerprints, perspiration, etc. Even a light coating of perspiration will reduce the effectiveness of the lamp. If the glass portion of the lamp is touched, clean it with a damp, lint-free cloth: use isopropyl alcohol as required.
4. Remove black cap by sliding off UV housing.
5. Insert the lamp halfway into the UV lamp chamber and plug it in, then fully insert the lamp into the chamber.
6. Make sure the UV lamp cable is tucked behind the chamber before closing and relatching the door.

---

## Other Accessories

Optional accessories for this unit include a float switch, low pressure switch, N.I.S.T. Traceable Calibration Module, remote dispenser, and printer. Installation procedures for these accessories are explained in later sections of this manual.



**Caution**

Wall composition, condition and construction, as well as fastener type, must be considered when mounting this unit. The mounting surface and fasteners selected must be capable of supporting a minimum of 150 lbs.(68 kg). Inadequate support and/or fasteners may result in damage to mounting surface and/or equipment. If you are unsure of mounting surface composition, condition and construction or correct fasteners, consult your building maintenance group or contractor.



**Note**

Please refer to the “General Specifications” section for clearance requirements.



**Warning**

Do not locate the NANOpure Diamond Life Science (UV/UF) directly over equipment that requires electrical service. Routine maintenance of this unit may involve water spillage and subsequent electrical shock hazard if improperly located.



**NOTE \*\*\*\*\*  
The outlet of a gravity feed storage reservoir must be above or at the same level as the inlet of the NANOpure Diamond Life Science (UV/UF).  
\*\*\*\*\***

---

## Bench Mounting

1. Place the NANOpure Diamond Life Science (UV/UF) on a bench top that is accessible to pretreated water, electricity and an atmospherically vented drain.

---

## Wall Mounting

Install the NANOpure Diamond Life Science (UV/UF) on a wall in a convenient location that is accessible to water, an atmospherically vented drain and electricity.

1. Locate the wall bracket packed separately from the unit.
2. Using the wall bracket as a template, locate and drill the mounting holes in the wall. A minimum of four (customer-supplied) fasteners will be required — two on the top and two on the bottom.
3. Attach the wall bracket to the wall using the customer-supplied fasteners.
4. Remove the locking screws on each side of the wall bracket.
5. Pull the two locking slides on each side of the wall bracket out as far as they will go.
6. Hang the unit on the wall bracket by sliding the mounting pins into the wall bracket slots.
7. Push the locking slides on each side of the wall bracket in as far as they will go.
8. Replace the locking screws.



**Note**

The removable control panel was not designed to be repeatedly removed from the unit, therefore, you may experience difficulty when attempting to remove it. It is therefore recommended that the control panel be permanently mounted in a remote location or remain intact with the unit.



**Caution**

Repeated removal and replacement of the control panel from the top cover may eventually cause it to become damaged.



**Note**

The blank protective cover on the rear side panel display connector should remain in place when the display is not remotely located.

Blank panel

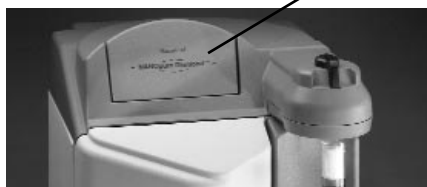

Wall Mount Bracket



## Installing the Control Panel in a Remote Location

For your convenience, the control panel can be removed from the unit and mounted at a convenient location within 10 ft. (3.1 m.) of the unit. To remove the control panel from the unit:

1. Turn the unit OFF and disconnect it from the power supply.
2. Slide the control panel upward about 1/4" (.64 cm) to 3/8" (.95 cm) - (just enough to clear connector on top cover), pull forward, and remove. (The control panel fits tightly in the unit so it may be difficult to remove.)
3. Replace the control panel with the blank panel provided with the unit to protect the electrical connector.
4. Using the wall bracket as a template, locate and drill the mounting holes in the wall. A minimum of two (customer-supplied) fasteners will be required. Attach the wall bracket to the wall using the customer-supplied fasteners.
5. Locate the 25-pin connector on the back top right of the unit. Remove the protective black cover and store it for future use if the control panel is returned to the top cover.
6. Locate the 10 ft. (3.1 m.) 25 pin M-F cable included with the unit; attach the female end to the 25 pin connector on the back top right of the unit, and the other end to the connector on the bottom of the control panel.
7. Tighten the cable screws on each end to secure the cable to the unit and control panel.
8. The control panel may now be mounted on the wall.



### Caution

Do not connect feed water until directed to do so during “Initial Sanitization.”

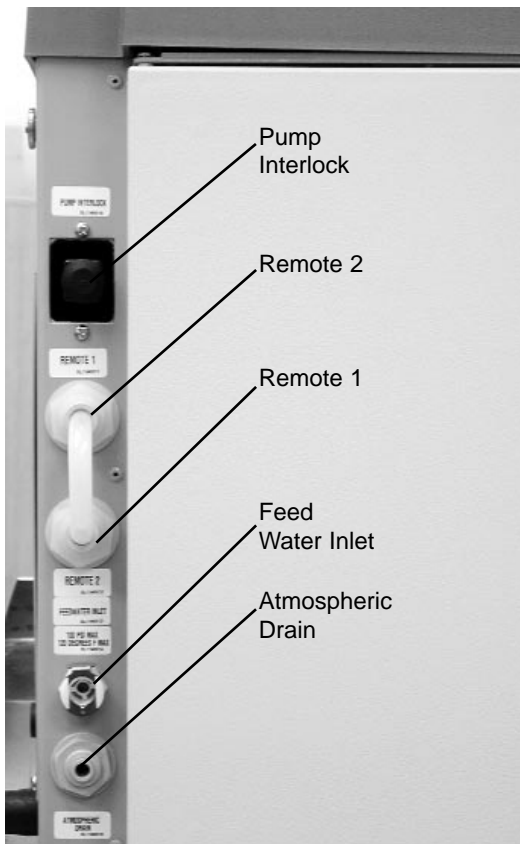

Water Connections - Left side view

## Water Connections

### Feed Water Connection

1. Locate the length of 3/8" O.D. tubing provided with the unit with a quick disconnect insert on one end and a 3/8" (.95 cm) O.D. X 1/4" (.64 cm) NPT tubing adapter on the other.
2. Install the tubing adapter onto your incoming water line. We recommend a customer supplied shut off valve be installed in your feed water line. Do not connect the feed water to your NANOpure Diamond Life Science (UV/UF). You will connect the feedwater during the “Initial Sanitization” procedure explained later in this manual. Note: The cartridge pack and ultrafilter must be installed before connecting water line.
3. If a pressure switch is to be used, see the “Installing a Float or Pressure Switch” section for more information.

### Atmospheric Drain Connection

When the NANOpure Diamond Life Science (UV/UF) flushes its membrane, the water used is sent to drain through this connection. To install:

1. Locate the drain water tubing. This is the 1/4" (.64 cm) O.D. tubing that is approximately 6 ft. (1.9 m.) long. The atmospheric drain fitting is located on the lower left side of the NANOpure Diamond Life Science (UV/UF).
2. Route the other end of the drain water tubing to an atmospherically vented drain and make a connection. Ensure there are no kinks in the tubing and that it proceeds in a downward plane. Proceed to “Initial Operation.”

# Controls



## Note

The removable control panel was not designed to be repeatedly removed from the unit, therefore, you may experience difficulty when attempting to remove it. It is therefore recommended that the control panel be permanently mounted in a remote location or remain intact with the unit.

## Main Power Switch

The main power switch on the NANOpure Diamond Life Science (UV/UF) is located on the lower back right side of the unit (as you face the front of the unit), directly above the power cord receptacle.

## Control Panel

The NANOpure Diamond Life Science (UV/UF) is controlled through a panel which incorporates switches to control its functions: START/STOP, STANDBY, DISPENSE, DOWN, UP, ENTER and BACK. This control panel utilizes a digital display to show system information and the purity of the product water. The intensity (brightness) of the display may be adjusted according to user preference. See “Adjusting Display Brightness” in the “User Settings” section of this manual.

A single LED located on the top of the control panel will illuminate to inform you of the system status as follows:

- LED is not illuminated: System is OFF or in (Idle) mode.
- Solid Green LED: System is recirculating and operating normally.
- Blinking Green LED: System is in Standby mode.
- Red LED: System is alerting user to an operational error or maintenance issue.

The control panel can be removed from the unit and remotely mounted. Please refer to “Installing the Control Panel in a Remote Location” in the “Installation” section of this manual for more information about how to remove the control panel from the unit.

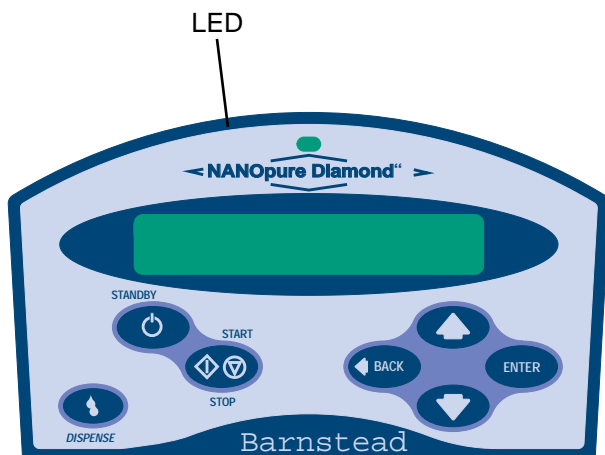

*NANOpure Diamond Life Science (UV/UF)  
Control Panel*

---

### Switches

When the main power switch (on the lower back right side of the unit as you face the unit) is ON, the switches on the control panel function as follows:

**START/STOP** allows you to alternate the unit between the normal (recirculation) mode; when the display is showing purity, and the (Idle) mode.

**STANDBY** allows you to put the unit into standby, recirculating water for 10 minutes/hour. The display will read "Standby" during periods of inactivity and "Recirculating" and the time remaining during the 10 minute recirculation.

**DISPENSE** allows you automatically deliver water from the unit. Please refer to "Automatic Dispensing" in the "User Settings" section of this manual for information.

**UP and DOWN** arrows allow you to scroll between menu options/items and values.

**BACK** allows you to return to the previous menu option/item. Please note that use of the BACK switch from a selection screen will return you to the previous menu option/item while maintaining the selection's value upon entry.

**ENTER** allows you to activate a selected menu option/item and also functions as "Yes" whenever an option with a question mark appears.

**DISPENSE KNOB** when the unit is in the recirculation mode, push to the right to deliver water continuously until pushed back to the middle. Push to the left to deliver water manually until button is released.



#### Note

The unit MUST be in the normal recirculating mode (when the display is showing purity) in order to dispense water.



# Initial Operation

Cartridge packs will come bagged with four manifold connection caps.

## Part      Application

### **Diamond Kit Organic Free R/O & Distilled Feed**

D50280 Ultra-Low Organics, Type 1 Water,  
Reverse Osmosis or Distilled  
Water Feed

### **Diamond Kit Organic Free Deionized Feed**

D50281 Ultra-Low Organics, Type 1 Water,  
Deionized Water Feed

### **Diamond Kit Type 1 R/O & Distilled Feed**

D50282 Low Organics, Type 1 Water,  
Reverse Osmosis or Distilled  
Water Feed

### **Diamond Kit Type 1 Deionized Feed**

D50283 Low Organics, Type 1 Water, DI  
DI Water Feed

*Each cartridge pack includes one 0.2 micron absolute final filter.*



#### **Warning**

Depressurize system prior to removing cartridge pack.



#### **Caution**

Do not allow the NANOpure Diamond Life Science (UV/UF) to operate unless water is available to the unit.



#### **Note**

Do not install the 0.2 micron filter and bell assembly at this time.



---

## Cartridge Pack Installation

1. Open front (left side) door. Turn the cartridge pack so the caps are facing you. Remove the caps.
2. Verify that each of the four posts on the cartridge pack has an o-ring.
3. Lift unit manifold upwards, insert cartridge pack and align the pack so that it mates with the unit manifold.
4. Lower unit manifold until it is flush with the top of the cartridge pack.
5. Hand tighten wing head screws securely.
6. Close door.



**Warning**

Use a properly grounded electrical outlet of correct voltage and current handling capacity.

---

## Initial Rinse

1. Attach the feed water line to the unit by snapping the quick disconnect coupling into the quick disconnect body in the lower left back of the unit.
2. Attach an atmospheric drain line [1/4" (.64 cm) ] tubing by pushing into the quick connect fitting on the lower left back of unit. See layout connection under the "Water Connections" section.
3. Check to ensure the dispense knob is in the OFF (middle) position.
4. Select the appropriate power cord, remove and install the two fuses into the fuse draw in the power entry module.
5. Connect/attach to proper electrical outlet and the unit.
6. Turn the unit on by turning the main power switch to the "I" (ON) position.
7. The system greeting will display the type of unit you own. This greeting is "UV/UF."
8. The system electronics will initialize and check its calibration. (All units have been factory calibrated.) If calibration is OK the display will show "Calibration (passed)." The display will next read "Self Test (in progress) Self Test. Passed." Finally, the display will read "10 ( $\pm 0.2$ ) M $\Omega$ -cm." This is a reading of the calibration reference value.
9. From the (Idle) mode, when the display reads, "NANOpure Diamond (Idle) xx:xx:xx xx/xx/xx," press ENTER to run an air purge.
10. Unit will display, "Air Purge?" Press ENTER.
11. Upon completion of the air purge, complete the "System Sanitization Procedure."

**Warning**

Avoid splashing disinfecting solution on clothing or skin.

Ensure all piping connections are tight to avoid leakage.

Ensure adequate ventilation.

Carefully follow manufacturer's safety instructions and material safety data sheets.

This device to be used with water feeds only.

Sanitizing/cleaning agents must be used in compliance with instructions in this manual. Failure to comply with the above could result in explosion and personal injury.

**Note**

After sanitization is complete, the sanitization timer will automatically be reset for approximately six months.



## System Sanitization Procedure

Your NANOpure Diamond Life Science (UV/UF) has been shipped with a cleaning syringe (Cat. No. CMX25). When the system is new or whenever a new cartridge pack is installed, the system should be sanitized (cleaned). For UV/UF units, it is best to perform sanitizing procedures when the system or water is not required. The entire sanitization procedure will take approximately 3.5 hours to complete. Sanitize your NANOpure Diamond as follows:

1. From the (Idle) display, press the UP or DOWN arrow until display reads, "Sanitize Unit?"
2. Press ENTER.
3. Unit display will ask if you have "Disconnected Inlet Water (NO)."
4. Disconnect feed water supply at the quick-disconnect inlet valve on left side of unit.
5. Press the UP or DOWN ARROW to select (YES) and then press ENTER. Display will now read, "Injected Sanitant (NO)."
6. Open front (left side door) to expose cartridge pack. Remove solution syringe from wrapper.
7. Remove luer cap on system injection port, located on the right side of the cartridge pack manifold by turning counterclockwise.
8. Remove syringe luer cap and attach syringe to the system luer fitting.
9. Slowly inject solution into system and remove syringe. Avoid injecting air into the system.
10. Replace luer cap on injection port and close door.
11. Press the UP or DOWN arrow to select (YES) and then press ENTER. Display will now read, "Reconnected Water (NO)."
12. Attach feed water supply removed in step 4.
13. Press the UP or DOWN arrow to select (YES)

## INITIAL OPERATION



0.2 Micron  
Filter



### Note

For more demanding applications where low TOC water is required, a rinse of 15-20 liters through the cartridges and 0.2 micron filter may be necessary.

and press ENTER. Display will now read, "Unit Sanitizing."

14. Unit may now be left unattended until display reads, "Sanitization Complete: Press ENTER."
15. After sanitization is complete the unit will return to the (Idle) mode.
16. Press the START/STOP switch to return the unit to the normal recirculation mode.
17. Remove the new 0.2 micron filter and bell assembly from the bag and insert it into the dispenser arm manifold. Gently turn it clockwise until it is fully seated.
18. Remove the protective cap from the filter bell. Turn the dispense knob to the left or right and flush 1-2 liters of water through the 0.2 micron filter. The product water is now ready for use.

# Normal Operation



## Note

On initial start-up, the purity meter may display "...MΩ-cm or uS/cm." This is caused by air in the cell and should be replaced by a resistivity reading almost immediately. If the dots aren't replaced by a value after one minute, refer to the "Troubleshooting" section of this manual.



## Note

Do not turn off the NANOpure Diamond Life Science UV/UF during non-work hours. Doing so will allow bacterial growth and other contamination of the water in the system. As a result, the system will require a rinse-up period at the beginning of the work day to achieve high quality product water. We recommend using the Standby Mode.



## Note

From the normal recirculating mode when the display is showing purity, press ENTER to show the current temperature. The temperature will display for about 5 seconds before returning to the normal recirculating mode.



## Note

Press any switch except ENTER to stop dispensing. Display will read, "Auto Dispense Interrupted by User."

1. Turn the system power ON by depressing the main power switch to the "I" position.
2. The system greeting display indicates the type of unit you own. This greeting is "UV/UF."
3. The system electronics will initialize and check its calibration. (All units have been factory calibrated.) If calibration is OK the display will show "Calibration (passed)." The display will next read "Self Test (in progress) Self Test. Passed." Finally, the display will read "10 (±0.2) MΩ-cm." This is a reading of the calibration reference value.
4. From an (Idle) display, press the START/STOP switch on the control panel to enter the normal recirculating mode. The unit's pump will begin to run.
5. The display will then begin reading resistivity of the product water. Initially it will read "... MΩ-cm" until the air is bled from the system.
6. Allow the water's resistivity to rise to the desired purity before drawing off water.
7. The system should be left on or in standby during the work day. (See "Use of Standby Mode.")

---

## Dispensing Water

Use the dispense knob for manual dispensing or, use the "Dispense" switch for volumetric or timed dispensing. See "User Settings."

---

## Automatic Dispensing

(Factory set to "OFF.") This feature is accessible only from the normal recirculating mode when the display is showing purity.

1. Place a container under the dispenser.
2. Press DISPENSE. **Water will start dispensing immediately!** Display will read, "xx.MΩ-cm xx Liters Remaining" or "xx.MΩ-cm xx Seconds Remaining," or "AUTO DISPENSE <OFF>" depending on which dispensing method was last chosen in the auto dispense menu.

---

# User Settings

---

## Adjusting Display Brightness

1. From the (Idle) mode, when the display reads, "NANOpure Diamond (Idle) xx:xx:xx xx/xx/xx," press the UP or DOWN arrow until display reads, "Advanced Menu?"
2. Press ENTER.
3. Press ENTER to proceed through the options until "Set Display Brightness" is displayed.
4. Press the UP or DOWN arrow to choose "Yes."
5. Press ENTER.
6. Press the UP or DOWN arrow until the desired value (100%, 75%, 50% or 25%) is displayed.
7. Press ENTER.
8. Press BACK until you return to the (Idle) display.



### Note

Time values are displayed in 24 hr. military time. For example; 6:00p.m. = 18:00:00 = hr./min./sec.)

---

## Setting the Displayed Language

1. From the (Idle) mode, when display reads, "NANOpure Diamond (Idle) xx:xx:xx xx/xx/xx," press the BACK switch until the display reads "LANGUAGE."
2. The currently selected language is displayed on line 2 of the display.
3. Press the UP or DOWN arrow to select the language desired.
4. Press ENTER.

---

## Setting the Date and Time

1. From the (Idle) mode, when the display reads, "NANOpure Diamond (Idle) xx:xx:xx xx/xx/xx," press the UP or DOWN arrow until display reads, "Advanced Menu?"

2. Press ENTER.
3. Press ENTER when the unit displays “Printer Attached?”
4. When prompted with “Date Format” press the UP or DOWN arrow to show the date format desired. Press ENTER to select the desired format and continue.
5. When prompted with “Set Date,” press the UP or DOWN arrow to choose “Yes,” then press ENTER.
6. Press the UP or DOWN arrow until you reach the desired month. Press ENTER.
7. Press the UP or DOWN arrow until you reach the desired day. Press ENTER.
8. Press the UP or DOWN arrow until you reach the desired year. Press ENTER.
9. When prompted with “Set Time” press the UP or DOWN arrow to choose “Yes,” then press ENTER. This is to set the time of day.
10. Press the UP or DOWN arrow until you reach the desired hour value. Press ENTER.
11. Press the UP or DOWN arrow until you reach the desired minute value. Press ENTER.
12. Press BACK twice to return to the (Idle) mode.

---

## Setting the Cell Constant

The actual temperature and cell constants are attached to the cell cable internal to the NANOpure Diamond unit. This data helps ensure that the purity displayed is as accurate as possible. The only time the user would need to enter this data is if the cell or main board is being replaced and/or updated.

1. Shut power OFF to the unit and disconnect the power cord.

---

## USER SETTINGS

2. Unlatch and open the right side door.
3. Find and copy down the two cell constants attached to the gray cable, leaving the electronics board mounted on the inside of the right side door.
4. Close and latch the right side door.
5. Reconnect the power cord and turn unit ON.
6. From the (Idle) mode, when the display reads, "NANOpure Diamond (Idle) xx:xx:xx xx/xx/xx," press the UP or DOWN arrow until the display reads, "Advanced Menu."
7. Press ENTER.
8. Proceed through the options by pressing ENTER until "Set Cell Constant" is displayed.
9. Press the UP or DOWN arrow to select "Yes."
10. Press ENTER.
11. Note that the digits are entered from left to right.
12. Press the UP or DOWN arrow to change the "blinking" digit. Once the digit is correct, press ENTER to advance to the next digit.
13. After all digits have been entered, line 2 of the display will read, "(NO) Finished."
14. If the cell constants displayed on line 1 of the display are correct, press the UP or DOWN arrow to select "Yes."
15. Press ENTER.
16. Press BACK twice to return to the (Idle) mode.





**Note**

When in Standby mode, press START/STOP to continue normal operation.

---

## Use of Standby Mode

At the end of the work day, place the NANOpure Dlamond Life Science (UV/UF) in Standby mode for the night. To place the unit in Standby mode:

1. From the (Idle) mode, when display reads, "NANOpure Dlamond (Idle) xx:xx:xx xx/xx/xx," press STANDBY.

—OR—

2. From the xx.x MΩ-cm or x.xx uS/cm operational display, Press STANDBY.

After STANDBY is pressed the display will read "Standby" and the green LED will slowly blink. For 10 minutes of every hour while the pump is energized, the display will read "Standby (Recirculating) xx minutes." Every fourth time the pump goes on in the standby mode, the UV light will go on. The lamp is on 10 minutes out of every four hours. Press START/STOP to return to the recirculating mode.

---

## Selecting the Set Point

The NANOpure Dlamond Life Science (UV/UF) electronics include a user programmable set point which alerts you when water quality falls below the programmed set point. The set point is user selectable from 1-18 MΩ-cm (factory set at 10 MΩ-cm.).

1. From the (Idle) mode, when display reads, "NANOpure Dlamond (Idle) xx:xx:xx xx/xx/xx," press the UP or DOWN arrow until display reads, "Advanced Menu?"
2. Press ENTER.
3. Proceed through the options by pressing ENTER until "Adjust Set Point" is displayed.
4. Press the UP or DOWN arrow to choose "Yes."
5. Press ENTER.
6. Press the UP or DOWN arrow until the desired value is displayed.

7. Press ENTER.
8. Press BACK to return to the (Idle) mode.

The second line of the display will show a "Below Set point" message once every 8 to 10 seconds when the measurement is below the set point. (The set point indication is set at the factory at 10 MΩ-cm.)

---

## Resetting the Sanitization Timer

1. From the (Idle) mode, when the display reads, "NANOpure Diamond (Idle) xx:xx:xx xx/xx/xx," press the UP or DOWN arrow until the display reads, "Reset Timers?"
2. Press ENTER. Display will read, "Reset UV Timer (NO)."
3. Press ENTER.
4. Display will read, "Reset San Timer" and show on the right side of the second line when the user will start receiving "Sanitize Unit" reminders.
5. Press the UP or DOWN arrow to select "Yes."
6. Press ENTER and the timer will be reset. This will reset the sanitization timer for approximately six months calendar time.

---

## Resetting the UV Timer

When the NANOpure Diamond Life Science (UV/UF) is in an (Idle) position:

1. From the (Idle) mode, when display reads, "NANOpure Diamond (Idle) xx:xx:xx xx/xx/xx," press the UP or DOWN arrow until the display reads, "Reset Timers?" Press ENTER.
2. Press the UP or DOWN arrow until the display reads, "Reset UV Timer."

3. Press the UP or DOWN arrow to select "Yes."
4. Press ENTER and the timer will be reset for approximately five months of operational time.

The display will now display "Rest San Timer." Press BACK two times to return to the (Idle) mode.



**Note**

Volumetric dispensing is based upon total fluid volume entering the NANOpure Diamond Life Science (UV/UF). Point of drawoff accuracy will be compromised if you are dispensing water volumetrically while simultaneously drawing water manually through the remote dispenser accessory.



**Note**

Once Volumetric or Timed Dispensing values are set, they will remain in memory until changed by the user. To turn the dispense method OFF, select "OFF" in the "Dispense Method" menu.

---

## Setting Volumetric Dispensing

1. From the normal recirculating mode, when the display is showing purity, press the UP or DOWN arrow until the display reads, "Auto Dispense Menu?"
2. Press ENTER.
3. Display will read, "Dispense Method." Press the UP or DOWN arrow to select VOLUMETRIC.
4. Press ENTER. Display will read, "Volume Setting: xx Liters."
5. Press the UP or DOWN arrow to set the desired volume value. Press ENTER.

UP arrow: +0.25 up to 1 L, then 5 L, then incremental by 5 L

DOWN arrow: Decrement by 1 L until 1 L, then by 0.25 L

Maximum: 60 L

Minimum: 0.25 L

---

### Setting Timed Dispensing

1. From the normal recirculating mode, when the display is showing purity, press the UP or DOWN arrow until the display reads, "Auto Dispense Menu?"
2. Press ENTER.
3. Display will read, "Dispense Method." Press the UP or DOWN arrow to select TIME.
4. Press ENTER. Display will read, "Time Setting: xx Minutes."
5. Press the UP or DOWN arrows to set the desired time value. Press ENTER.

UP arrow: +1 up to 5 min., then increments by 5 minutes  
DOWN arrow: Decrement by 1 minute  
Maximum: 40 minutes  
Minimum: 1 minute



#### Note

An automatic 1-minute flush will occur once every 12 hours. If a unit is (Idle) or in STANDBY for over 12 hours, an automatic system flush will occur immediately after the START/STOP switch is pressed.



#### Note

Press the STOP/STOP switch to cancel the flush.

---

### Performing a System Flush

1. From the normal recirculating mode, when the display is showing purity, press the UP or DOWN arrow until the display reads, "System Flush?" Press ENTER.
2. Press the UP or DOWN arrow to select "Short Flush?" or "Extended Flush?" Press ENTER.
3. Display will read, "System Flushing: (xxx) Seconds or (xxx) Minutes Remaining."

---

### Changing Purity Units

(Factory set to "mΩ-cm.")

1. From the normal recirculating mode, when the display is showing purity, press the Up or DOWN arrow until display will reads, "Change Units?" Press ENTER.

2. Press the UP or DOWN arrow to select “MΩ-cm” or “uS/cm” Press ENTER.
3. Press BACK to return to the normal recirculating mode.



**Note**

Purity displayed will have an asterisk (\*) the the left of the reading (\* xx.x MΩ-cm or \* x.xx uS/cm) to inform the user that uncompensated purity is being displayed.

---

## Temperature Compensation

(Factory set to “ON.”)

1. From the normal recirculating mode, when the display is showing purity, press the Up or DOWN arrow until the display reads, “Temperature Compensation?” Press ENTER.
2. Press the UP or DOWN arrow to select “OFF” or “ON” Press ENTER.
3. Press BACK to return to the normal recirculating mode.

# Installing Float or Pressure Switch

Accessories D8964 (float switch) and D2706 (pressure switch) are designed to protect the NANOpure Diamond Life Science (UV/UF) pump by alerting the system of an inadequate feed water condition so that the pump can be shut down. If an inadequate feed water condition exists and the pump is shut down due to this condition, the display will read "Check Inlet." Follow the preceding instructions for installation.

1. Disconnect the unit from the electrical power.
2. If using the D8964 float switch, follow the installation instructions included with the float switch for installation into a tank.
3. If using the D2706 low pressure switch, install the PVC tee (supplied with D2706) in the incoming water line. Screw the switch into the top of the tee, then connect the inlet tubing of the NANOpure Diamond Life Science (UV/UF) into the remaining opening of the PVC tee.
4. Route the cable from the float or low pressure switch to the top left of the NANOpure Diamond Life Science (UV/UF).
5. Remove the jumper plug from the back, upper left portion of the unit and save for future use.
6. Plug the cable into the jumper plug outlet.
7. Reconnect the electrical power.

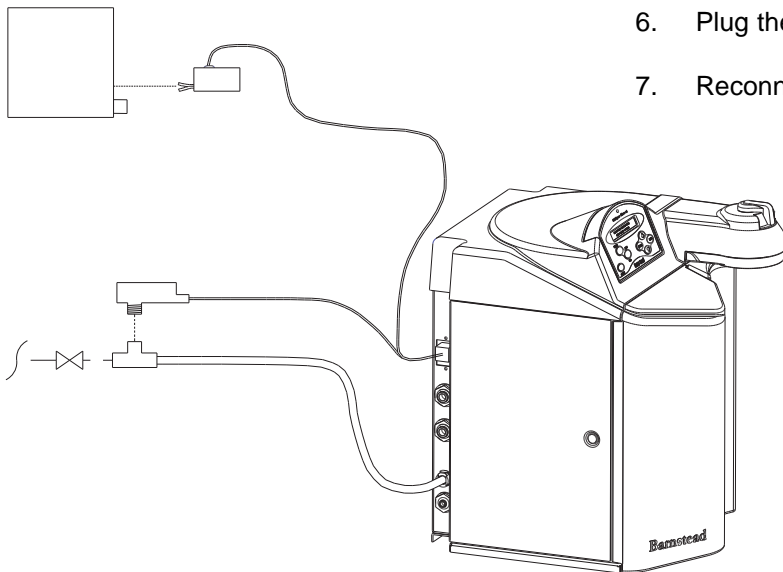

# N.I.S.T Calibration Module

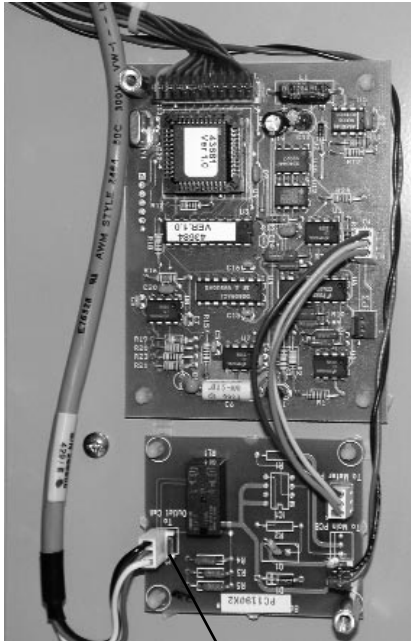

PC Board

J2  
Connection



## Note

The calibration (in progress) may take up to two minutes to complete.

## Performing an Electronic Calibration Using the Optional N.I.S.T. Calibration Module

If you purchased the optional N.I.S.T. calibration module (Catalog No. E896X5) you can perform a calibration of the NANOpure Diamond purity sensing electronics traceable to N.I.S.T. standards.

1. Disconnect power cord from the unit.
2. Unlatch and open the right door. Remove the 2 screws and remove the cover plate over the PC boards.
3. Locate the outlet cell connection on the circuit board and remove the outlet cell connection at P2.
4. Connect the N.I.S.T. calibration module to the connection point (J2), "To Outlet Cell" on the calibration board (PC1190X2).
5. Close and latch door.
6. Reconnect the power cord and turn the unit on by depressing the main power switch.
7. From the (Idle) mode, Press the UP or DOWN arrow until the display reads, "N.I.S.T. Calibrate?" Press ENTER.
8. Display will show "Calibration Module Installed?" Press the UP or DOWN arrow to select (YES).
9. Press ENTER.
10. Display will read "Calibration (In Progress)." When the calibration is complete the display will read "Calibration (passed/failed) for 4 seconds and then return to the "N.I.S.T. Calibrate?" display.

11. Press BACK to return to the (Idle) mode.
12. Turn the main power switch to the OFF "O" position. Unplug the unit.
13. Remove the calibration module and reconnect the cell.
14. Reattach the cover plate and close and latch the door.
15. Reconnect the power cord.

The calibration procedure is complete.

---

## **Remote Dispenser**

Refer to the Operating Instructions for your remote dispenser.



---

# Computer/Printer Setup

---

## Connecting NANOpure Diamond to Computer and Communicating Through the RS-232 Port Using Hyperterminal or Procomm

---

### Hyperterminal

#### RS-232 Capture Instructions

1. Connect the 9 pin serial cable (part no. WHX18) from the NANOpure Diamond RS-232 port to COM2: port or (COM1: port) on back of computer.
2. From the (Idle) display, press the UP or DOWN arrow until display reads, "Advanced Menu."
3. Press ENTER.
4. From the "Printer Attached" display, press the Up or DOWN arrow for (NO).
5. Press ENTER.
6. Now, during the normal Recirculation mode, date, time, purity and temperature readings will be sent to the computer once per minute.
7. Run your Microsoft Windows program. Open Hyperterminal (located in the accessories directory), give your setting a name and choose a symbol.
8. In the "Connect Using:" box, select "direct to" COM2: or (COM1: ) as port (depending on your computer), and click OK.
9. Using the selection boxes in the next screen, configure the options as 9600 baud, 8-bit, No parity, 1 stop bit, Flow Control: None.
10. To receive data to a file, select Transfer and



#### Note

Due to character set differences, hyperterminal may display the  $\Omega$  symbol as  $\hat{e}$ . Also, the  $\circ$  symbol may be displayed as  $\emptyset$ .

capture text. Accepting default will put the file which you name in the c:/windows directory called capture.txt and the file will be an ASCII text file.

11. You should see the data on the computer screen.
12. When you are finished storing data from the NANOpure Diamond, save your file. You can exit Hyperterminal or set up a new experiment.
13. Hyperterminal data can be manipulated and graphed in Excel<sup>®</sup>.

---

## Procomm

1. Connect the 9 pin serial cable from the NANOpure Diamond RS-232 port to COM2: port or (COM1: port) on back of computer.
2. From the (Idle) display, press the UP or DOWN arrow until the display reads, "Advanced Menu."
3. Press ENTER.
4. From the "Printer Attached" display. Press the Up or DOWN arrow for (NO).
5. Press ENTER.
6. The unit will now, during the normal Recirculation mode send a purity and temperature reading to the computer once per minute.
7. Open DOS window and change directory to procomm directory.
8. Open procomm executable.
9. Press ALT-F10 for configuration screen.
10. Enter into Line Settings screen by typing ALT-P.
11. Type in 11 <Enter>, sets parameters as 9600, 8, N, 1.

12. Type in 21 <Enter>, sets to COM2: or (Type in 20 <Enter>, sets to COM1:), depending on your computer.
13. Type in 24 <Enter>, saves settings.
14. Type ESC to exit setup menu.
15. Procomm is now ready to accept input from the NANOpure Dlamond.
16. To begin downloading a file, Type ALT-F1, and give the file an appropriate name when prompted.

The optional printer (part no. AY1137X1) provides a paper tape record for future reference.

During normal Recirculation, the printer prints date, time, purity and temperature readings once every minute.

---

## Connecting and Starting the Printer

1. Make sure the printer and NANOpure Dlamond are turned OFF.
2. Connect the NANOpure Dlamond to the printer via the RS232 port. Use the tan printer cable included with the Epson printer. Plug the printer power cord into an electrical outlet.
3. Turn the NANOpure Dlamond ON.
4. Turn the printer ON.
5. From the (Idle) display, press the UP or DOWN arrow until display reads, "Advanced Menu."
6. Press ENTER.

7. From the "Printer Attached" display, press the Up or DOWN arrow for (YES).
8. Press ENTER.
9. Press BACK twice to return to the (Idle) mode.
10. During normal Recirculation mode, a purity and temperature reading will be printed once every 12 minutes.

---

## Printer Setup

---

### Power Switch

Located on the front of the printer (AY1137X1), this switch turns power to the printer ON and OFF. (See Figure A.) The green POWER light will illuminate when the printer is ON.

---

### Paper Feed Button

Press this button once to advance the tape one line, or hold the button down to advance paper continuously. When the paper roll nears the end, the red PAPER OUT light will illuminate.

If the red ERROR light illuminates, the printer is off line. This could be a result of the print head being too hot, in which case the printer will resume printing once it cools down; or—the paper may be jammed in the printer. Turn the printer OFF before checking for jammed paper. Remove the paper jam and turn the printer back ON. If the printer still will not print, unplug it and refer servicing to qualified personnel.

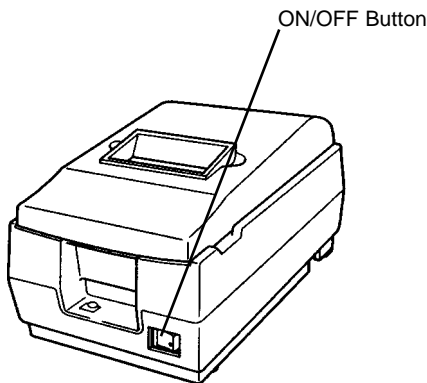

Figure A: Printer

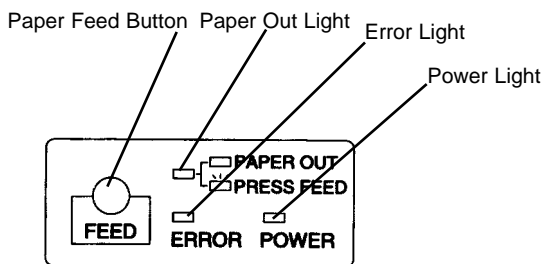

Figure B: Control Panel

**Note**

A colored stripe along the edge of the paper indicates that you are approaching the end of the tape. When the stripe appears, approximately 23 inches (58.4 cm) of paper remains, enough for 1-2 days. Replace the tape before it is completely exhausted to ensure a complete record of your analyses.

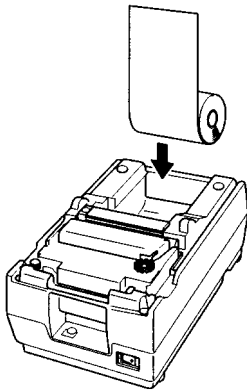

Figure C: Inserting the Paper Roll

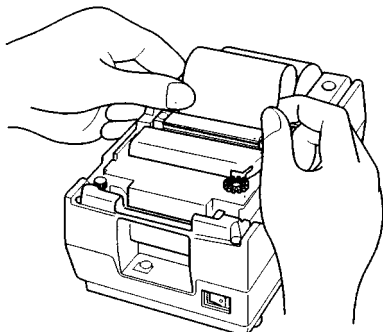

Figure D: Inserting the Paper Into the Paper Slot

## Installing the Paper Roll

When the red PAPER OUT light illuminates, it is time to replace the paper roll. Replace the paper roll (AY669X4) as follows:

1. Turn the printer ON and open the chamber cover.
2. Make sure the edge of the paper roll is straight.
3. Insert the paper roll into the printer. (See Figure C.)
4. Insert the paper straight into the paper slot (see Figure D). The paper will feed automatically.
5. Tear off a strip of paper and close the cover. (The red PAPER OUT light will be OFF if paper roll installation is successful.)

# Maintenance and Servicing



## Warning

- Avoid splashing mild detergent or weak acid on clothing or skin
- Ensure all piping connections are tight to avoid chemical leakage
- Carefully follow manufacturer's safety instructions on labels of chemical containers and material safety data sheets.



## Caution

Feed water must be disconnected and the system must be depressurized before performing the cell cleaning procedure.

---

## General Cleaning Instructions

Disconnect electrical service to the unit. Wipe exterior surfaces with lightly dampened cloth containing mild soap solution.

---

## Cell Cleaning

1. Disconnect inlet water and depressurize. See "System Depressurization" section.
2. Turn unit OFF. Open right side door and remove pc board cover.
3. Disconnect cable from J2 and snip plastic cable tie located on the inside top of unit.
4. Unscrew and remove the cell by turning the gray bushing counterclockwise. Carefully remove O-ring to clean the cell.
5. Wash the cell in a mild detergent solution or a 10% inorganic acid solution (follow acid manufacturers recommended handling procedure). This may be done in an ultrasonic cleaner or with a soft brush.
6. Thoroughly rinse the cell in deionized or distilled water following the detergent or acid cleaning.
7. After cleaning, check the o-ring; replace if necessary.
8. Reinstall the cell into the cell well and hand tighten.
9. Reroute the cable and reconnect to J2 on circuit board.
10. Replace pc board cover and close door.
11. Reconnect water and turn unit ON.



**Note**

The sanitization timer will display after six months, reminding you to sanitize the unit. Complete the system sanitization procedure and reset the sanitization timer according to the “Resetting the Sanitization Timer” section in this manual.



**Warning**

Disconnect from the power supply prior to maintenance and servicing.



**Warning**

Refer servicing to qualified personnel.



**Warning**

Avoid splashing disinfecting solution on clothing or skin.

Ensure all piping connections are tight to avoid leakage.

Ensure adequate ventilation.

Carefully follow manufacturer’s safety instructions and material safety data sheets.

This device to be used with water feeds only.

Sanitizing/cleaning agents must be used in compliance with instructions in this manual. Failure to comply with the above could result in explosion and personal injury.

## System Sanitization

For UV/UF units, it is best to perform cleaning procedures early in the afternoon. After sanitization is complete (approximately 3.5 hours), place the unit into its normal (recirculation) mode to allow the system to recirculate overnight after cleaning.

1. From the (Idle) mode, press the UP or DOWN arrow until the display reads, “Sanitize Unit?”
2. Press ENTER.
3. Display will prompt, “Disconnected Inlet Water (NO).”
4. Disconnect feed water supply at the quick-disconnect inlet valve.
5. Press the UP or DOWN ARROW to select (YES) and then press ENTER. Display will now prompt, “Injected Sanitant (NO)?”
6. Remove solution syringe from wrapper.
7. Open front (left side) door. Remove luer cap on system injection port, located on the right side of the cartridge pack manifold by turning counterclockwise.
8. Remove the syringe luer cap and attach the syringe to the system luer fitting.
9. Slowly inject the solution into the system and remove syringe. Avoid injecting air into system.
10. Replace luer cap on injection port. Close door.
11. Press the UP or DOWN arrow to select (YES) and then press ENTER. Display will now read, “Reconnected Water (NO).”
12. Attach feed water supply removed in step 4.
13. Press the UP or DOWN arrow to select (YES) and press ENTER. Display will now read, “Unit Sanitizing.”



**Warning**

Depressurize system prior to removing cartridge pack.

14. Unit may now be left unattended until the display reads, "Sanitization Complete: Press ENTER."
15. After sanitization is complete and the user presses "ENTER" the unit will return to the (Idle) mode.
16. Press the START/STOP switch to return the unit to the normal recirculating mode.

---

## System Depressurization

This should be done prior to removing a cartridge pack or an ultrafilter. The unit needs to be plugged in and operating to correctly perform this depressurization step.

1. **IMPORTANT:** Disconnect inlet water from the left back of unit.
2. From the (Idle) display, press ENTER.
3. From "Air Purge?" press the UP arrow.
4. From "Depressurize" press the UP arrow to select (YES).
5. Press ENTER. Display will show "System Flushing" and the time remaining as the system depressurizes.





**Warning**

Depressurize system prior to removing cartridge pack.



**Warning**

A full cartridge pack may weigh about 20 lbs. (9 kg).

## Cartridge Pack Replacement

The frequency with which you will need to clean your unit and replace your cartridge pack is dependent on your feed water's characteristics, your purity requirements and your usage. Sanitize your NANOpure Diamond Life Science (UV/UF) and replace the cartridge pack when the product water purity drops below acceptable levels of resistivity, when organic levels become too high, or if a new 0.2 micron filter clogs rapidly after installation even though the cartridge pack was thoroughly rinsed before the 0.2 micron filter was installed. The simple-to-use cleaning syringe is available from BarnsteadThermolyne (Catalog Number CMX25). This is used to effect a complete sanitization.

1. Remove the feed water line by depressing the stainless steel thumb pad.
2. Depressurize the system by opening the remote dispenser or, from an operational unit in the normal recirculating mode, push the dispense knob to dispense water until no more water flows.
3. Shut power OFF to the unit and disconnect the electrical service to the unit.
4. Open the front ( left side) door.
5. Loosen the wing head screws on the cartridge manifold.
6. Remove the exhausted cartridge pack by lifting the unit manifold and pulling the cartridge pack out.
7. Install new cartridge pack, rinse and sanitize according to the instructions in the "Initial Operation" section.



## MAINTENANCE AND SERVICING



### Caution

Do not overtighten the 0.2 micron filter or use excessive force in seating it. The filter can be damaged by over-tightening or excessive force.



### Note

If a newly installed 0.2 micron filter clogs rapidly after installation, the NANOpure Diamond Life Science (UV/UF) may need to be sanitized to remove bacterial contaminants. See "System Sanitization."



0.2 Micron Filter



### Note

Depressurize the system before removing the ultrafilter.



### Note

Some water will drain from the ultrafilter when it is disconnected. Make sure a sink, bucket or other water-proof container is available to place the ultrafilter in while it drains. Water will also drain from the tubing onto the bench or floor. To avoid slipping and falling, clean up all spills immediately.



### Note

Do not install the ultrafilter until the NANOpure Diamond Life Science (UV/UF) is ready for use. If the unit sits for longer than 96 hours without use, it will become contaminated and may affect product water quality.

---

## 0.2 Micron Filter Replacement

Replace the 0.2 micron final filter whenever any of the following conditions occur: every 30 days, the product water flow rate is reduced or bacteria break through. To replace the 0.2 micron filter assembly:

1. Remove the old 0.2 micron filter assembly by turning it counterclockwise until it is free from the dispense arm manifold.
2. Remove the new 0.2 micron filter assembly from the bag and insert it into the dispense arm manifold. Gently turn it clockwise until it is fully seated.
3. Remove the protective cap from the filter bell.
4. Rinse 1-2 liters of water through the filter to drain prior to using the product water.

---

## Ultrafilter Replacement

The length of your ultrafilter's life will depend to some extent on conditions and use in your lab. When you are unable to completely sanitize your system (i.e. you can no longer get pyrogen-free water even after sanitizing the system), replace the ultrafilter as follows:

1. Disconnect feed water and depressurize the system according to "System Depressurization" under the "Maintenance and Servicing" section.
2. Turn the NANOpure Diamond Life Science (UV/UF) OFF and disconnect it from the power supply.
3. Open the front (right side) door and right side door.
4. Separate the velcro strap from the ultrafilter.
5. Simultaneously push and hold the collet in using the tool supplied with the ultrafilter while pulling the top fitting out of the connector. Refer to photo on next page.
6. Unscrew tubing with luer fitting from the top side port of the ultrafilter.

7. Pull the ultrafilter out of the unit and turn it to the left side. (This will make it easier to disconnect the bottom fitting.)
8. Using the tool supplied with the ultrafilter, simultaneously push and hold the collet on the ultrafilter in while pulling the bottom fitting out of the connector. See photo.
9. Install new ultrafilter according to "Ultrafilter Installation" in the "Installation" section of this manual.
10. Sanitize the NANOpure Diamond Life Science (UV/UF) according to the "System Sanitization" section of this manual.

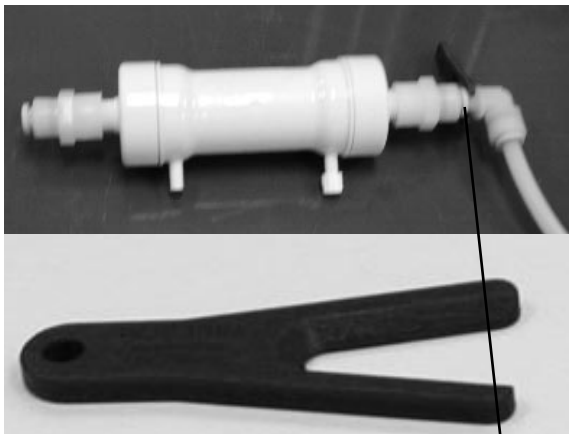

*Tool used for ultrafilter removal*

Collet



*Ultrafilter Installation*

- Top connector
- Collet
- Velcro strap
- Metal bracket
- Collet
- Bottom connector

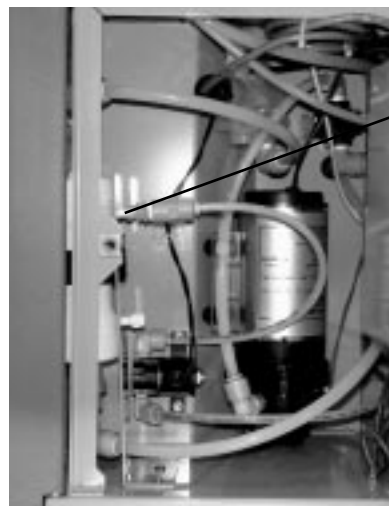

*Ultrafilter Connections - Right side view*

Tubing with luer fitting



### Warning

This unit is equipped with an ultraviolet lamp. Ultraviolet radiation is harmful to the eyes and skin. Do not attempt to observe the lamp directly.



### Note

The NANOpure Diamond Life Science (UV/UF) display will read “Check UV Lamp” when the lamp is burned out or disconnected.



### Note

After approximately 5 months of operation, the display will periodically show a reminder to change the lamp.



### Note

The UV lamp contains mercury. If broken or no longer needed, do not dispose of the UV lamp in the trash. Recycle or dispose of the UV lamp as hazardous waste.



*UV Lamp Installation*

## UV Lamp Replacement

The ultraviolet lamp requires changing every 5-6 months. Lamp Life will vary according to the number of times the NANOpure Diamond Life Science (UV/UF) is turned on and off (the START/STOP mode). This estimated lamp life is based on the NANOpure Diamond being operated in the normal recirculating mode during regular working hours and then placed in the Standby mode during off hours. Every fourth time the pump goes on in the Standby mode, the UV light will go on. If the NANOpure Diamond Life Science (UV/UF) is cycled between the normal and Standby modes during the workday, this will result in a shorter lamp life. Therefore, it is recommended that the NANOpure Diamond (UV/UF) be left in the normal recirculating mode during regular working hours.

### To replace the UV lamp:

1. Turn the NANOpure Diamond Life Science (UV/UF) OFF and disconnect power cord from unit.
2. Access the left side of the unit by unlatching the screw securing the door with a flathead screwdriver. Unlatch and open the door. The UV lamp will be installed vertically.
3. Remove the black cap by sliding it off the UV chamber. Disconnect and remove old UV lamp and dispose of it in the proper manner (see Note).
4. Remove the UV lamp from its packaging. DO NOT TOUCH THE GLASS PORTION OF THE LAMP! It is recommended that lint-free gloves be worn when handling the lamp. The glass portion must be free of fingerprints, perspiration, etc. Even a light coating of perspiration will

reduce the effectiveness of the lamp. If the glass portion of the lamp is touched, clean it with a damp, lint-free cloth: use isopropyl alcohol as required.

5. Insert the lamp halfway into the UV lamp chamber and plug UV cable in, then fully insert the lamp into the chamber.
6. Make sure the UV lamp cable is tucked behind the chamber before closing and relatching the door.
7. Reconnect the power cord. Turn unit ON.
8. Reset UV Timer according to "Resetting the UV Timer."
9. Operate normally.

**Warning**

Replace fuses with those of the same type and rating.

---

## Fuse Replacement

1. Turn off the NANOpure Diamond Life Science (UV/UF) and disconnect it from the power supply by removing the power cord directly below the main power switch on right side of unit. Locate the fuse drawer above the power cord receptacle.
2. Pull out the fuse drawer located in the power entry module.
3. Remove old fuses and replace with fuses of the same type and rating. (See "Replacement Parts.")
4. Replace fuse drawer.
5. Reattach the power cord.
6. Operate normally.

---

## **Shutdown**

If the NANOpure Diamond Life Science (UV/UF) is to be shut down for an extended period of time, the unit should be completely drained and the cartridge pack removed to prevent the growth of bacteria. If the system has remained inactive and full of water for more than 96 hours, the unit should be drained, sanitized and new cartridge pack installed prior to use.

# Troubleshooting

<b>Problem</b>	<b>Possible Causes</b>	<b>Solutions</b>
NANOpure Diamond completely inactive (pump and display not operating.)	No electrical power to NANOpure Diamond.	Ensure NANOpure Diamond power cord is connected to a live power source and completely plugged into electrical outlet as well as power entry module on the unit. Make sure on/off switch is in the "I" (on) position.
	Main fuse(s) blown.	Replace the main fuse(s) as indicated in "Fuse Replacement."
	Power supply fuse blown	Contact customer service concerning power supply fuse replacement.
Reduced or no product flow from the dispense arm or remote dispenser (if attached).	0.2 micron filter clogged.	Replace final filter as indicated in "0.2 Micron Filter Replacement" section. Reconnect feed water.
	UF module clogged.	
Display reads, "Check Inlet" and pump does not run.	Feed water not connected.	
	Pump protector (in reservoir), feed water line pressure switch or jumper plug not connected to pump interlock.	Connect the pump protector, jumper plug or pressure switch cord to the receptacle located on the upper left hand section of the NANOpure Diamond.
	Insufficient feed water pressure or volume to satisfy the NANOpure Diamond.	Open feed water line shut off, connect feed water line to NANOpure Diamond and ensure sufficient pressure or sufficient water level in the feed water reservoir).
Display reads, "...MΩ-cm" for more than 10 seconds.	Air in cell.	If you just started your NANOpure Diamond, wait 1 minute to see if it corrects itself.
	Bad cell connection.	Check connection of the cell as it attaches to the circuit board.
Recirculated water will not rinse up to desired purity level.	Exhausted cartridge pack.	Replace cartridge pack as indicated in "Cartridge Pack Replacement."
Short cartridge pack life.	Cartridge pack is beyond expiration date.	Check the expiration date. Cartridge packs begin to lose capacity after being stored for 2 years from the date of manufacture. Replace the cartridge pack with an unexpired one.

## TROUBLESHOOTING

	Poor quality feed water.	<p>If a Barnstead ROpure is the feed water source, check that the membrane is functioning properly.</p> <p>If a Barnstead Still is the feed water source, ensure that the distillate temperature to the NANOpure Diamond does not exceed 40°C (104°F).</p> <p>If feed water is from a central water purification system, verify water quality and proper functioning of the system. See “General Specifications.”</p>
The display periodically reads, “Check UV Bulb.”	UV lamp not connected properly.	Check to ensure lamp is connected properly.
	UV lamp burned out.	Replace the UV lamp as described in “UV Lamp Replacement.”
Purity display continuously “OVERRANGE.”	Air in system.	Dispense more water through the NANOpure Diamond to purge air from the unit.
	Bad cell connection.	Check the connection of the cell as it attaches to the meter circuit board mounted on the inside of the right door.
	Incorrect N.I.S.T. calibration offset.	<p>If you have a N.I.S.T. module, perform a N.I.S.T. calibration.</p> <p>If you do not have a N.I.S.T. module, perform the calibration function WITHOUT the calibration module (as if you had it; answer (YES) to prompt. The display will read “Calibration (failed)” but this will clear any incorrect offset to zero.</p>
Display reads, “Overpressure Error.”	0.2 micron filter clogged.	Replace final filter as indicated in “0.2 Micron Filter Replacement.”



Display reads, "Meter Board Problem."	PC board communication error.	Turn the NANOpure Dlamond OFF (I/O Switch) and restart the unit.
	System electronics failure.	Replace the resistivity meter board mounted on the inside of the right door.
Water is leaking between the manifold and the cartridge pack.	Wing head screws are not tight enough.	Tighten wing head screws on unit manifold.
	New cartridge pack: o-ring missing from post (each of the 4 posts must contain an o-ring.)	Disconnect inlet water and depressurize system. Next, disconnect the manifold and verify/replace missing o-ring. Reinstall cartridge pack as indicated in "Cartridge Pack Replacement."

# Replacement Parts

## Recommended Spares

### Consumables

Consumable parts are those required to support the day-to-day operation of this equipment. Barnstead|Thermolyne establishes two types of consumables; those items that must periodically be replaced to maintain performance (filters, resin cartridges, etc.) and other items of limited life (indicator lights, fuses, etc.) that you can expect to replace on a more or less random basis. Where practical, Barnstead|Thermolyne recommends the frequency of replacement, or provides information on life expectancy from which you may calculate a replacement interval compatible with your usage pattern. The replacement of consumable parts is discussed in the Maintenance and Servicing section to assist you in accomplishing your own service.

Consumables may be ordered separately and in some cases, as an expendables kit. Check with your Barnstead|Thermolyne representative for additional information on the expendables kit.

<u>Description</u>	<u>Catalog No.</u>	<u>Recommended Quantity</u>
<b>Diamond Kit Organic Free R/O &amp; Distilled Feed</b>	D50280	1
<b>Diamond Kit Organic Free Deionized Feed</b>	D50281	1
Final Filter	D3750	2
Main Fuse, 120 Volt - Slow Blow, 1.6 Amp, 250V	FZX47	2
Main Fuse, 230 Volt - Type T Time Lag, 0.63 Amp, 250V	FZX54	2
Teflon <sup>®</sup> Tape, Roll	06078	1
UV Lamp	LMX13	2
Main Transformer Fuse, Type F Fast-Acting, 3.15 Amp, 250 Volt	AZ9027	1
Sanitization Solution	CMX25	2
Ultrafilter	FL1192X1	1

### General Maintenance Parts

General maintenance parts are defined as laboratory level repair parts which do not require great expertise or special tools for installation. **Barnstead|Thermolyne** recommends that you stock the general maintenance parts as an aid to ensuring the continued operation of this equipment.

<u>Description</u>	<u>Catalog No.</u>	<u>Recommended Quantity</u>
Quick Disconnect Inlet	CUX11	1
Quick Disconnect Insert 3/8" tube	CUX9	1
Cartridge Pack O-Rings	GSX68	4

<sup>®</sup> Teflon is a registered trademark of DuPont.

---

## Safety Stock

For critical applications where performance with minimum downtime is required, **Barnstead|Thermolyne** recommends that you maintain a local stock of those parts listed in the General Maintenance Parts and Safety Stock sections.

<u>Description</u>	<u>Catalog No.</u>	<u>Recommended Quantity</u>
Display	SW1190X2	1
External Display cable (Remote Display Use)	WHX20	1
Main PC Board	PC1190X1	1
Recirculation Pump & Motor	PU1190X1	1
Pressure Regulator		1
Resistivity Cell	E896X4	1
Solid State Ballast UV	SC1191X1	1
Quartz Sleeve, UV Lamp	TU733X1	1
Power Supply PC Board	TNX116	1
Calibration PC Board	PCX48	1
Resistivity Meter PC Board	PC896X2	1
Check Valve	PMX214	1
Wire Harness, UV Bulb	WH1191X1	1
Flow Sensor	ME1190X1	
Flush Solenoid	RY1190X3	1
Unit Manifold		
Dispenser Manifold		
Dispense Switch	SW1190X1	1

---

## Optional Accessory Ordering Information

<u>Description</u>	<u>Catalog No.</u>
N.I.S.T. Calibration Module	E896X5
Low-Pressure Switch	D2706
Float Switch	D8964
Remote Dispenser	D11981
Serial Cable for Communication with Computer	WHX18
Printer (120-240 VAC system)	AY1137X1
Printer Replacement Paper Roll	AY669X4

# Flow Chart

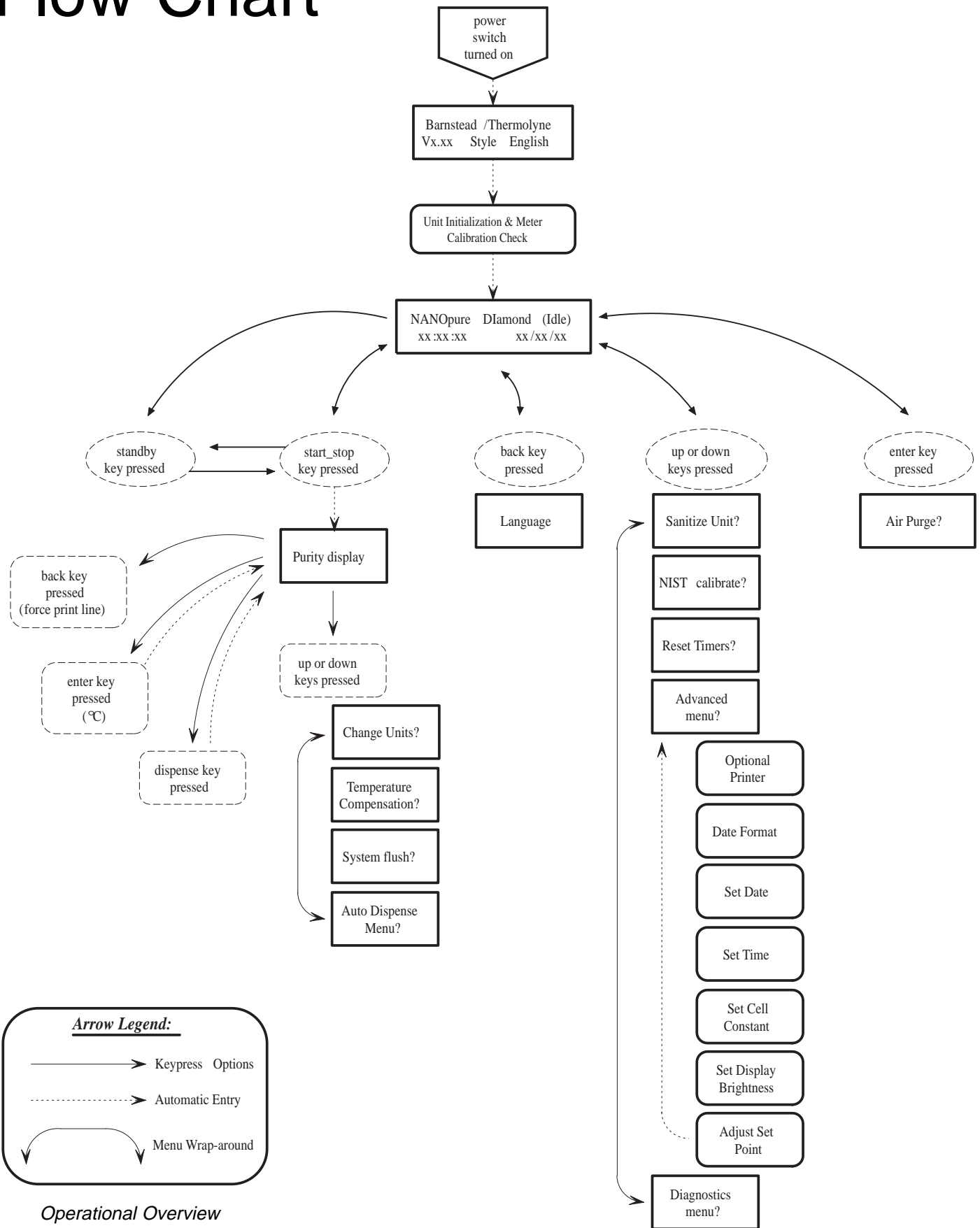

# Wiring Diagram

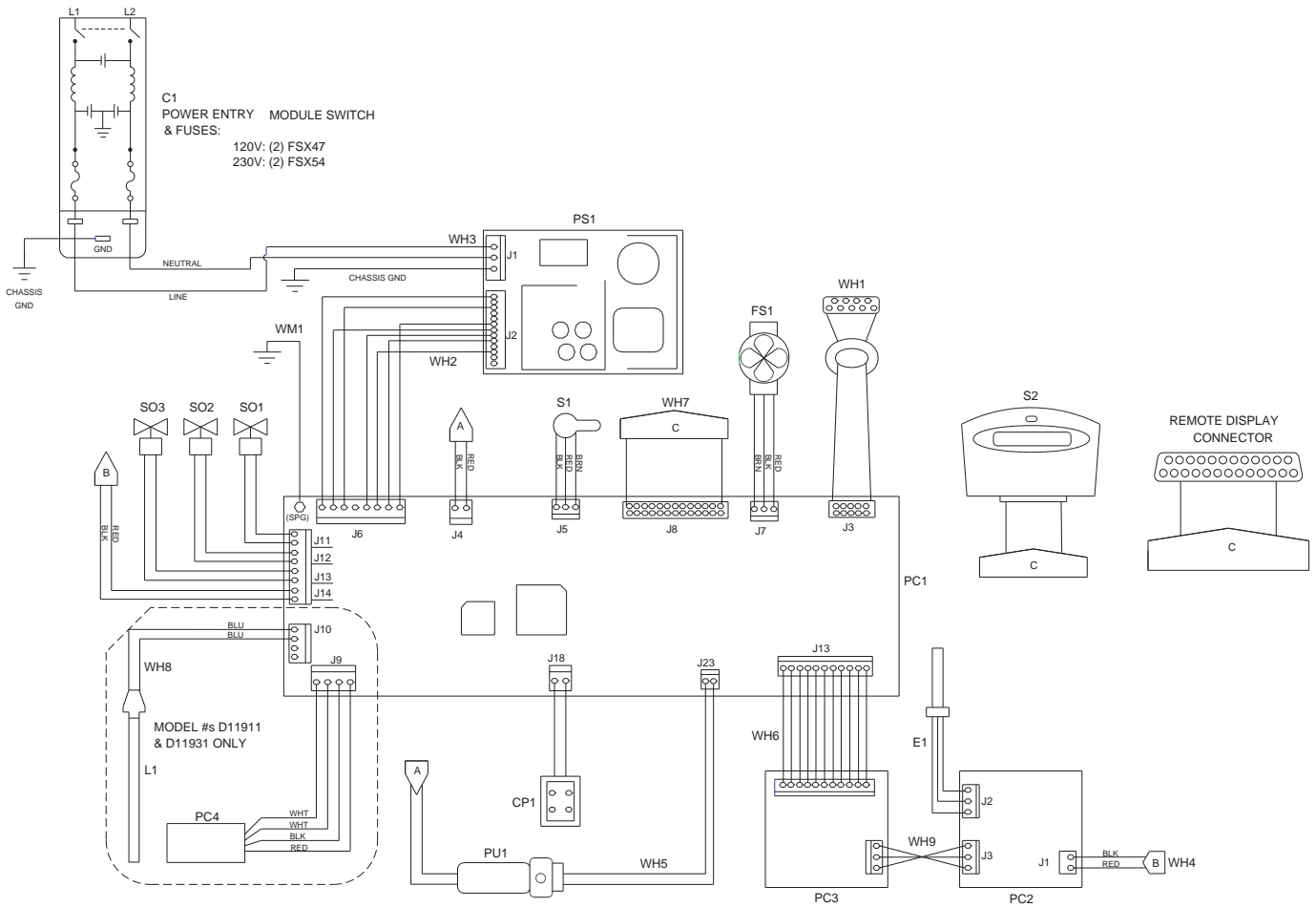

DIAGRAM COMPONENT LIST

REF. NO.	DESCRIPTION	MODEL NO. AND OUR PART NO.(s)			
		D11901	D11911	D11921	D11931
C1	POWER ENTRY MODULE	CEX183	CEX183	CEX183	CEX183
CP1	PUMP CONNECTOR	CE896X2	CE896X2	CE896X2	CE896X2
E1	CONDUCTIVITY CELL	E896X4	E896X4	E896X4	E896X4
FS1	FLOW SENSOR	ME1190X1	ME1190X1	ME1190X1	ME1190X1
L1	UV LAMP	LMX13	LMX13	LMX13	LMX13
PC1	MAIN CONTROL BOARD	PC1190X1	PC1190X1	PC1190X1	PC1190X1
PC2	CALIBRATION BOARD	PC1190X2	PC1190X2	PC1190X2	PC1190X2
PC3	METER BOARD	PC896X2	PC896X2	PC896X2	PC896X2
PC4	BALLAST	SC1191X1	SC1191X1	SC1191X1	SC1191X1
PU1	PUMP	PU1190X1	PU1190X1	PU1190X1	PU1190X1
PS1	POWER SUPPLY	TNX116	TNX116	TNX116	TNX116
S1	DISPENSE SWITCH	SW1190X1	SW1190X1	SW1190X1	SW1190X1
S2	MEMBRANE SWITCH	SW1190X2	SW1190X2	SW1190X2	SW1190X2
SO1	DIVERTER SOLENOID	RY1190X2	RY1190X2	RY1190X2	RY1190X2
SO2	DRAWOFF SOLENOID	RY1190X1	RY1190X1	RY1190X1	RY1190X1
SO3	FLUSH SOLENOID	RY1190X3	RY1190X3	RY1190X3	RY1190X3
WH1	PRINTER HARNESS	WH1190X1	WH1190X1	WH1190X1	WH1190X1
WH2	DC POWER HARNESS	WH1190X2	WH1190X2	WH1190X2	WH1190X2
WH3	AC POWER HARNESS	WH1190X3	WH1190X3	WH1190X3	WH1190X3
WH4	CAL. BOARD HARNESS	WH1190X4	WH1190X4	WH1190X4	WH1190X4
WH5	PRESSURE SW. HARNESS	WH1190X5	WH1190X5	WH1190X5	WH1190X5
WH6	METER BOARD HARNESS	WH1190X6	WH1190X6	WH1190X6	WH1190X6
WH7	DISPLAY HARNESS	WHX19	WHX19	WHX19	WHX19
WH8	LAMP HARNESS	WH1191X1	WH1191X1	WH1191X1	WH1191X1
WH9	CAL./METER HARNESS	WM896X2	WM896X2	WM896X2	WM896X2
WM1	GROUND WIRE	WM1190X2	WM1190X2	WM1190X2	WM1190X2

---

# Ordering Procedures

Please refer to the Specification Plate located inside the left side door for the complete model number, serial number, and series number when requesting service, replacement parts or in any correspondence concerning this unit.

All parts listed herein may be ordered from the Barnstead|Thermolyne dealer from whom you purchased this unit or can be obtained promptly from the factory. When service or replacement parts are needed we ask that you check first with your dealer. If the dealer cannot handle your request, then contact our Customer Service Department at 319-556-2241 or 800-553-0039.

Prior to returning any materials to Barnstead|Thermolyne Corp., please contact our Customer Service Department for a "Return Goods Authorization" number (RGA). Material Returned without an RGA number will be returned.

---

# One Year Limited Warranty

**Barnstead|Thermolyne Corporation** warrants that if a product manufactured by Barnstead|Thermolyne and sold by it within the continental United States or Canada proves to be defective in material or construction, it will provide you, without charge, for a period of ninety (90) days, the labor, and a period of one (1) year, the parts, necessary to remedy any such defect. Outside the continental United States and Canada, the warranty provides, for one (1) year, the parts necessary to remedy any such defect. The warranty period shall commence either six (6) months following the date the product is sold by Barnstead|Thermolyne or on the date it is purchased by the original retail consumer, whichever date occurs first.

All warranty inspections and repairs must be performed by and parts obtained from an authorized Barnstead|Thermolyne dealer or Barnstead|Thermolyne (at its own discretion). Heating elements, however, because of their susceptibility to overheating and contamination, must be returned to our factory, and if, upon inspection, it is concluded that failure is not due to excessive high temperature or contamination, warranty replacement will be provided by Barnstead|Thermolyne. The name of the authorized Barnstead|Thermolyne dealer nearest you may be obtained by calling 1-800-446-6060 (319-556-2241) or writing to:

**Barnstead|Thermolyne**  
P.O. Box 797  
2555 Kerper Boulevard  
Dubuque, IA 52004-0797  
USA  
FAX: (319) 589-0516  
E-MAIL ADDRESS: [mkt@barnstead.com](mailto:mkt@barnstead.com)

**Barnstead|Thermolyne's** sole obligation with respect to its product shall be to repair or (at its own discretion) replace the product. Under no circumstances shall it be liable for incidental or consequential damage.

THE WARRANTY STATED HEREIN IS THE SOLE WARRANTY APPLICABLE TO **Barnstead|Thermolyne** PRODUCTS. **Barnstead|Thermolyne** EXPRESSLY DISCLAIMS ANY AND ALL OTHER WARRANTIES, EXPRESSED OR IMPLIED, INCLUDING WARRANTIES OF MERCHANTABILITY OR FITNESS FOR USE.

---

## **Barnstead|Thermolyne**

2555 Kerper Blvd. A Sybron laboratory products company

P.O. Box 797

Dubuque, IA 52004-2241

Phone: 319-556-2241 800-553-0039

Fax: 319-589-0516

E-Mail Address: [mkt@barnstead.com](mailto:mkt@barnstead.com)

